















Year 6 Summer-Themed
Maths Activity Booklet

Answers



Place Value Code Breaker





									
3	1	6	5	4	0	8	7	2	9

What is the number						rounded to the nearest 10?
--------------------	---	---	---	---	---	----------------------------

Answer: 62 550

What is the number						rounded to the nearest 100?
--------------------	---	---	---	---	---	-----------------------------





Answer: 30 200

What is the number						rounded to the nearest 1000?
--------------------	--	--	---	--	--	------------------------------





Answer: 50 000

What is the number					written in Roman numerals?
--------------------	---	---	---	---	----------------------------

Answer: MMMCLVII

What is the number					written in Roman numerals?
--------------------	---	---	---	---	----------------------------

Answer: MDXIV

What is the number					written in Roman numerals?
--------------------	---	---	---	---	----------------------------

Answer: MMLXVI

Calculations Code Breaker

Solve the calculations and use the code breaker to spell out a summer-themed joke. The joke will read down the tables.

A	B	C	D	E	F	G	H	I	J	K	L	M
6	15	21	5	13	24	18	7	12	1	25	19	9

N	O	P	Q	R	S	T	U	V	W	X	Y	Z
22	16	11	26	2	17	20	3	10	8	14	23	4

	Answer	Letter
$\frac{2}{5}$ of 20	8	W
$\frac{1}{7}$ of 49	7	H
$\frac{1}{2}$ of 46	23	Y

	Answer	Letter
$\frac{1}{6}$ of 30	5	D
$\frac{4}{5}$ of 20	16	O

	Answer	Letter
$\frac{5}{6}$ of 18	15	B
$\frac{2}{6}$ of 18	6	A
$\frac{2}{3}$ of 33	22	N
$\frac{1}{4}$ of 24	6	A
$\frac{1}{2}$ of 44	22	N
$\frac{1}{5}$ of 30	6	A
$\frac{1}{2}$ of 34	17	S

	Answer	Letter
$\frac{1}{8}$ of 24	3	U
$\frac{1}{3}$ of 51	17	S
$\frac{1}{3}$ of 39	13	E

	Answer	Letter
$\frac{1}{4}$ of 68	17	S
$\frac{1}{5}$ of 15	3	U
$\frac{2}{5}$ of 55	22	N

	Answer	Letter
$\frac{1}{2}$ of 42	21	C
$\frac{1}{10}$ of 20	2	R
$\frac{1}{4}$ of 52	13	E
$\frac{1}{9}$ of 54	6	A
$\frac{3}{5}$ of 15	9	M?

	Answer	Letter
$\frac{1}{2}$ of 30	15	B
$\frac{1}{8}$ of 104	13	E
$\frac{1}{3}$ of 63	21	C
$\frac{1}{2}$ of 12	6	A
$\frac{1}{3}$ of 9	3	U
$\frac{1}{5}$ of 85	17	S
$\frac{1}{5}$ of 65	13	E

	Answer	Letter
$\frac{2}{3}$ of 30	20	T
$\frac{1}{3}$ of 21	7	H
$\frac{1}{3}$ of 39	13	E
$\frac{1}{2}$ of 46	23	Y

	Answer	Letter
$\frac{1}{3}$ of 33	11	P
$\frac{1}{4}$ of 52	13	E
$\frac{1}{8}$ of 104	13	E
$\frac{1}{2}$ of 38	19	L

Colour by Calculation



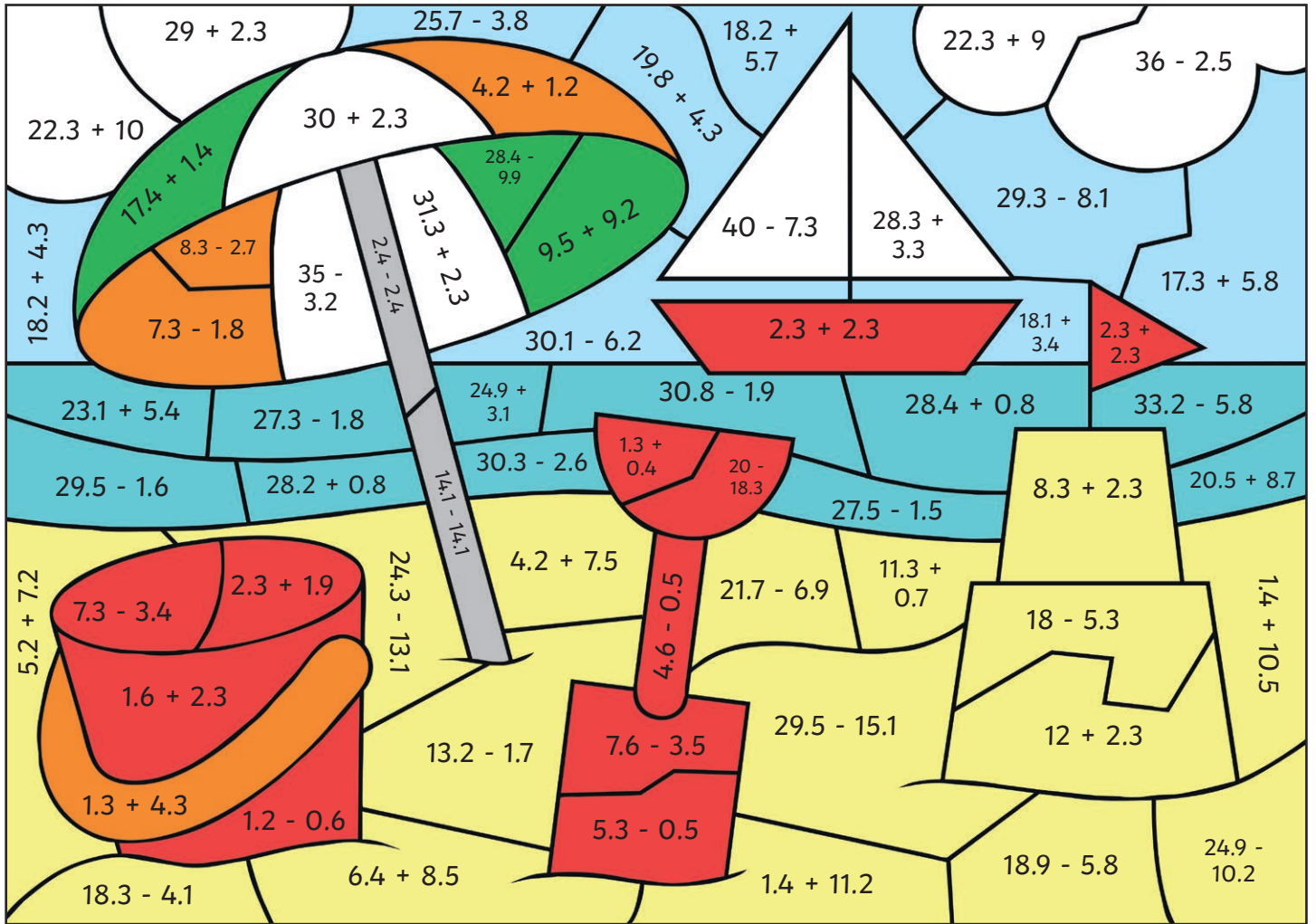



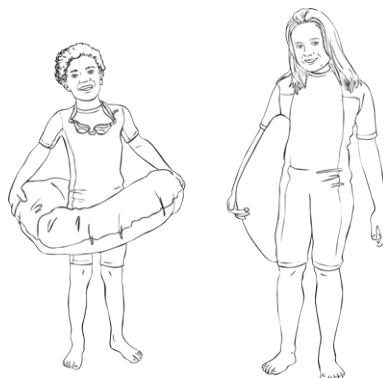



Use the key to colour the summer-themed picture.







Grey:	Red:	Orange:	Yellow:	Green:	Light Blue:	Dark Blue:	White:
0	1 - 5	5.1 - 10	10.1 - 15	15.1 - 20	20.1 - 25	25.1 - 30	30.1 - 35







Written Methods of Multiplication and Division Code Breaker

									
2	4	8	6	1	0	5	9	3	7

1.				×		
----	---	---	---	----------	---	---





Answer: **336 × 85 = 28 560**

2.				×		
----	---	---	---	----------	---	---





Answer: **318 × 72 = 22 896**

3.					÷	
----	---	---	---	---	----------	---

Answer: **2148 ÷ 4 = 537**

4.					÷	
----	---	---	---	---	----------	---

Answer: **7128 ÷ 9 = 792**

5.					÷	
----	---	---	---	---	----------	---

Answer: **3430 ÷ 7 = 490**

Summertime Addition and Subtraction Maths Mosaic

Solve the calculations to reveal the hidden picture. Each answer has a special colour.

green = 7200 | **pink** = 7500 | **black** = 7800 | **blue** = 8100 | **yellow** = 8400

$2650 + 5450$	$9972 - 1872$	$1788 + 6612$	$5589 + 2811$	$8369 + 31$	$9959 - 1559$	$1528 + 6872$	$757 + 7343$	$7619 + 481$
$2107 + 5993$	$6475 + 1925$	$4660 + 3740$	$2461 + 5939$	$8417 - 17$	$958 + 7442$	$6194 + 2206$	$9859 - 1459$	$9526 - 1426$
$5959 + 1841$	$8263 - 463$	$1171 + 6629$	$715 + 7085$	$4865 + 2935$	$3101 + 4699$	$5518 + 2282$	$1036 + 6764$	$4399 + 3401$
$9584 - 1184$	$7554 + 246$	$6999 + 801$	$677 + 7123$	$5590 + 2810$	$8688 - 888$	$9892 - 2092$	$333 + 7467$	$9860 - 1460$
$4334 + 4066$	$1577 + 6823$	$1920 + 5880$	$1787 + 6613$	$5588 + 2812$	$8370 + 30$	$8360 - 560$	$4335 + 4065$	$1576 + 6824$
$9270 - 870$	$7308 + 1092$	$3886 + 4514$	$8703 - 303$	$6238 + 2162$	$7083 + 1317$	$3591 + 4809$	$1162 + 7238$	$4200 + 4200$
$7787 + 613$	$7787 + 613$	$3886 + 4514$	$8703 - 303$	$7308 + 1092$	$7787 + 613$	$3073 + 5327$	$7456 + 944$	$6726 + 1674$
$3979 + 4421$	$8434 - 34$	$5927 + 1573$	$5124 + 2376$	$6329 + 1171$	$8233 - 733$	$8899 - 1399$	$3980 + 4420$	$9335 - 935$
$6967 + 233$	$3887 + 4513$	$8704 - 304$	$1042 + 6458$	$1964 + 5536$	$8825 - 1325$	$5589 + 2811$	$8360 + 40$	$2546 + 4654$
$1827 + 5373$	$658 + 6542$	$6475 + 1925$	$4660 + 3740$	$2461 + 5939$	$8417 - 17$	$958 + 7442$	$3043 + 4157$	$4380 + 2820$

Summer Number Puzzles

I collect some shells on the beach.
I multiply the number of shells I have by 7.
I then subtract 7,
multiply by 9,
and divide by 2.
I end with the number 1953.
How many shells did I collect? **63 shells**

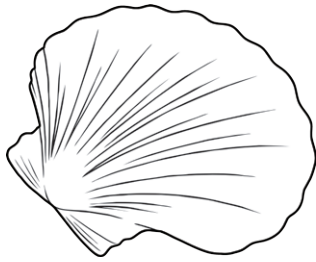

I decorate my sandcastle with flags.
I multiply the number of flags I use by 26.
I then add 132,
multiply by 4,
and divide by 10.
I end with the number 344.
How many flags did I use to decorate
my sandcastle? **28 flags**

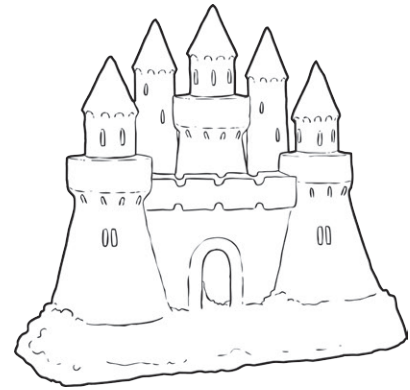

I practise cartwheels on the sand.
I multiply the number of cartwheels
I do by 38.
I then subtract 83,
multiply by 100,
and divide by 4.
I end with the number 19 775.
How many cartwheels did I do?
23 cartwheels

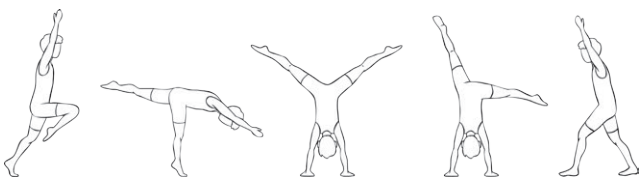

Pirate Flags



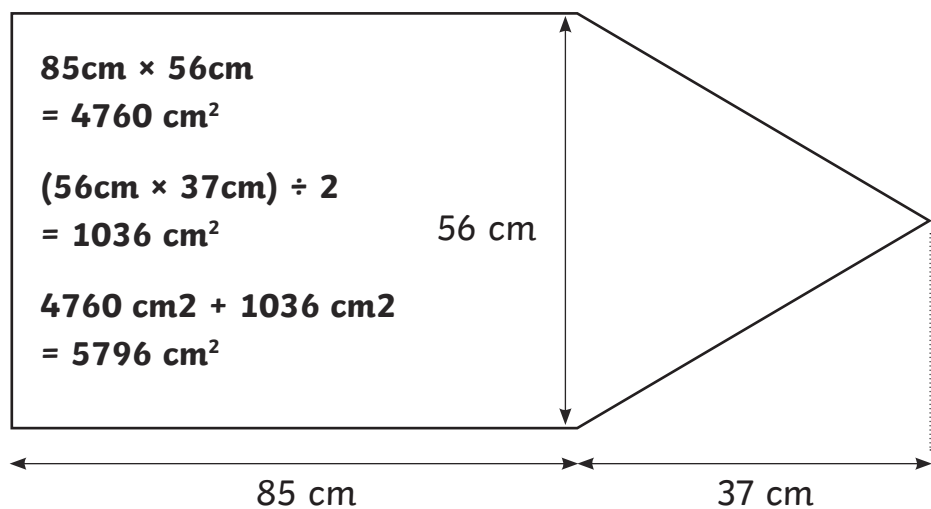
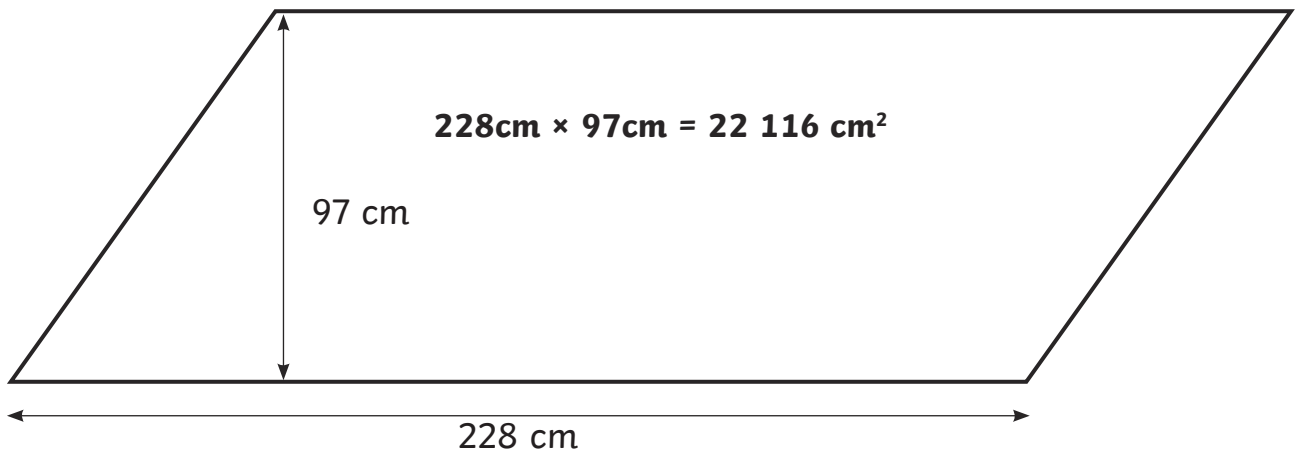
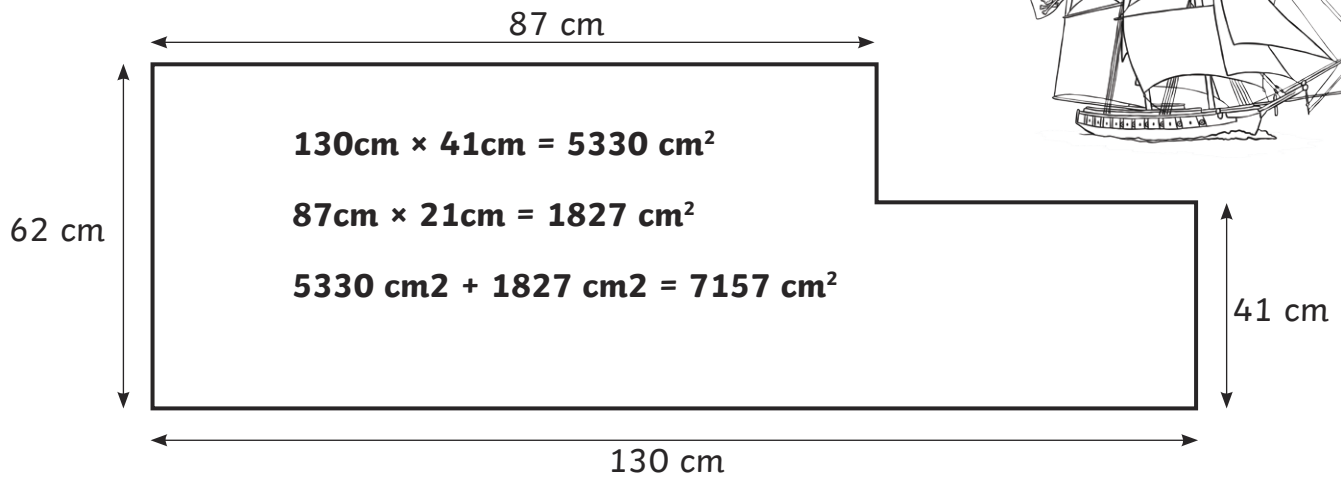

Use the dimensions to calculate the area of each pirate flag.
(Not drawn to scale)

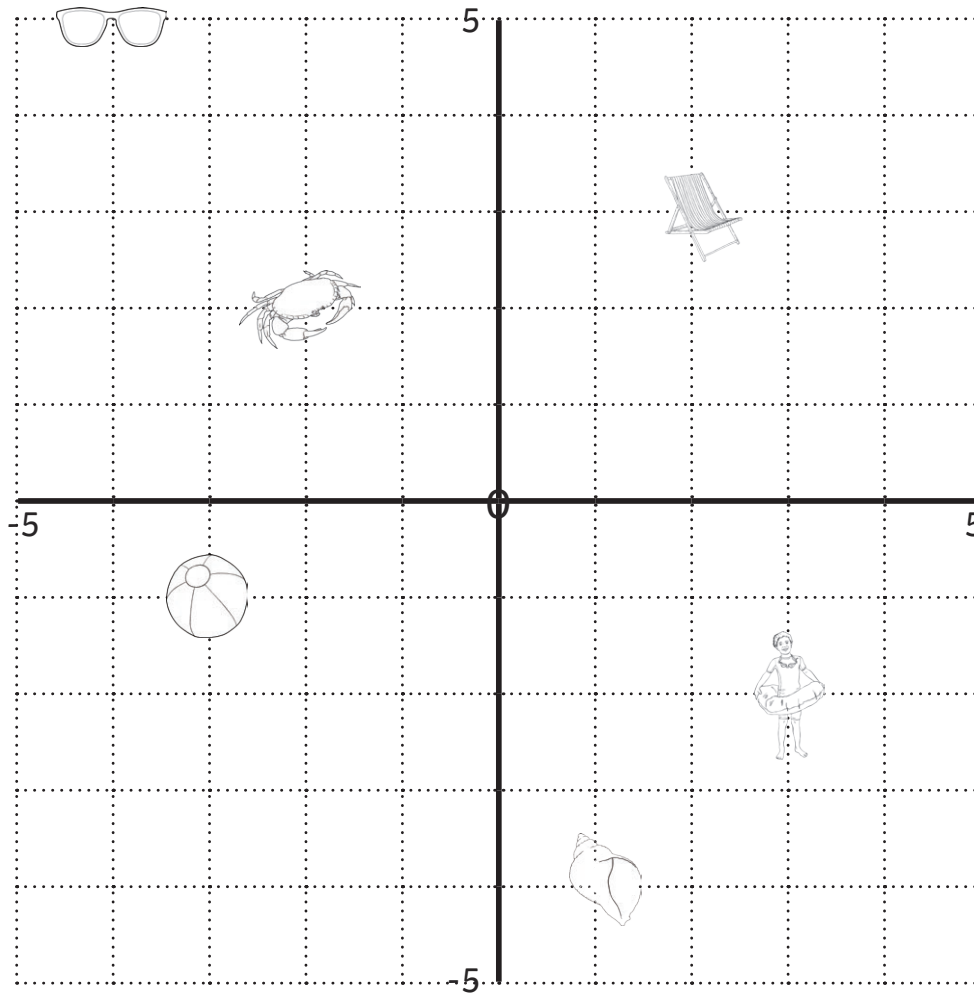

Summer-Themed Coordinate Translations

Write the coordinates of the summer-themed objects. Translate them and write the new coordinates.



Object	Starting Coordinate	Translation	Finishing Coordinate
	(-3, -1)	Right 4, Up 6	(1, 5)
	(-4, 5)	Right 5, Down 7	(1, -2)
	(3, -2)	Left 4, Down 3	(-1, -5)
	(-2, 2)	Left 1, Up 2	(-3, 4)
	(1, -4)	Right 3, Down 1	(4, -5)
	(2, 3)	Right 1, Up 2	(3, 5)

Summer Holiday Pie Chart

Count the summer-themed objects carefully. Represent the results as a pie chart.

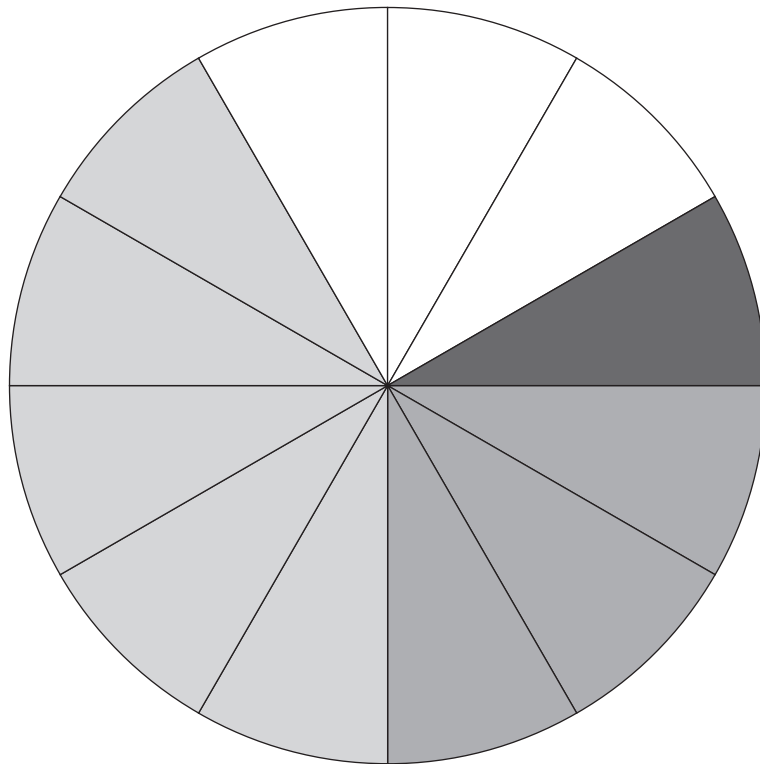
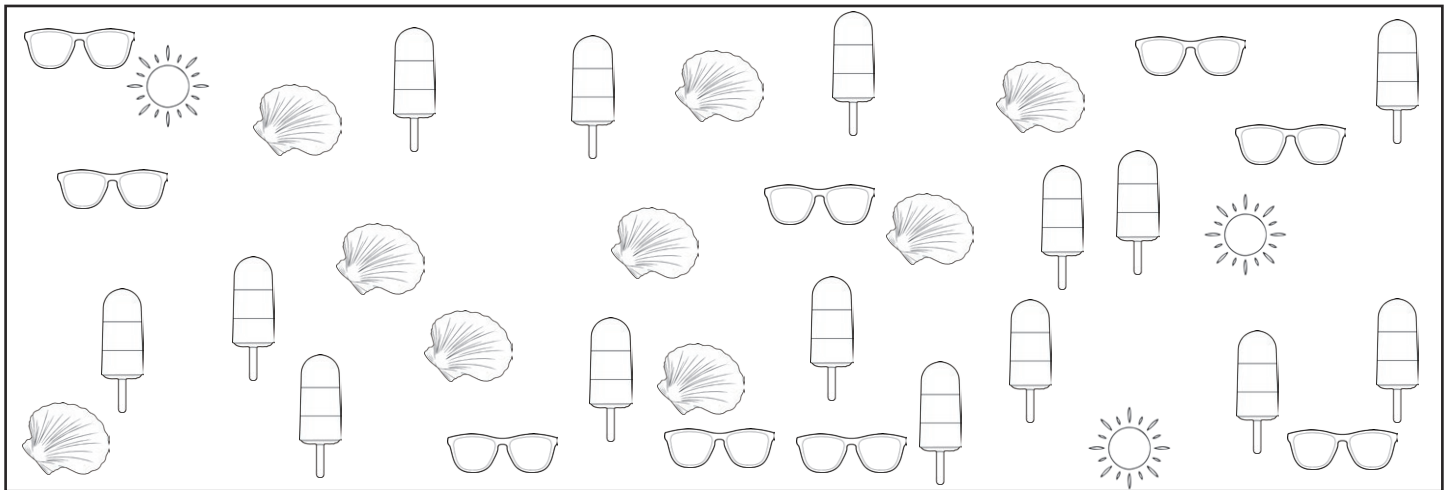

Item	Pie Chart Colour	Frequency	Fraction	Number of Pie Chart Segments
Sun	Dark grey	3	$\frac{3}{36} = \frac{1}{12}$	1
Sea shell	Medium-dark grey	9	$\frac{9}{36} = \frac{1}{4}$	3
Ice lolly	Medium-light grey	15	$\frac{15}{36} = \frac{5}{12}$	5
Sunglasses	Light grey	9	$\frac{9}{36} = \frac{1}{4}$	3