

Draw shapes accurately

1 a) Draw a square with a perimeter of 20 cm.

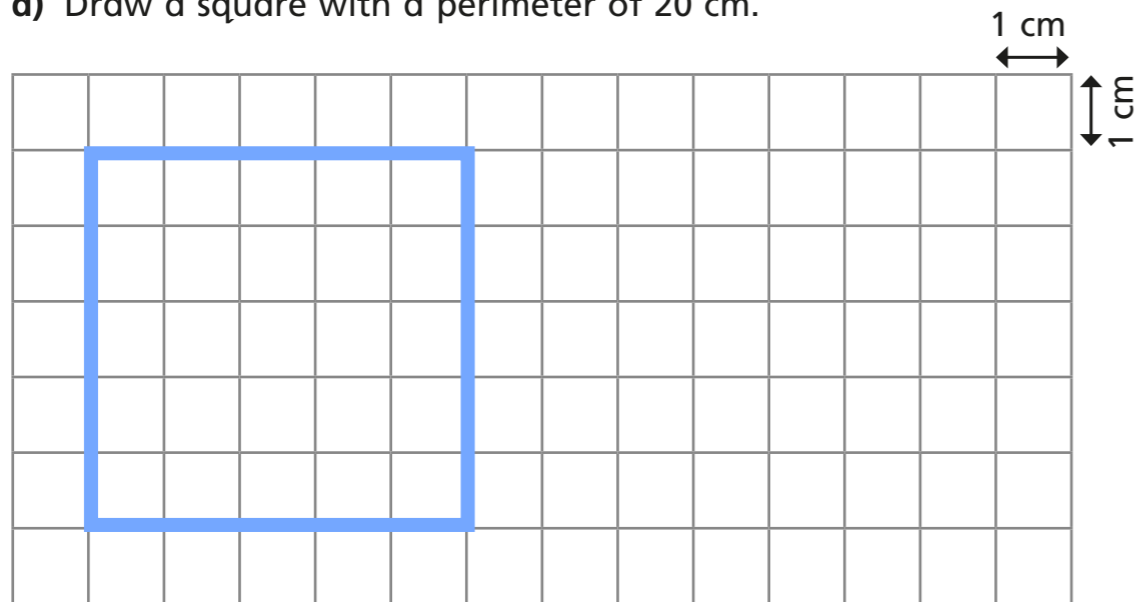

b) Draw a rectangle with a perimeter of 20 cm.

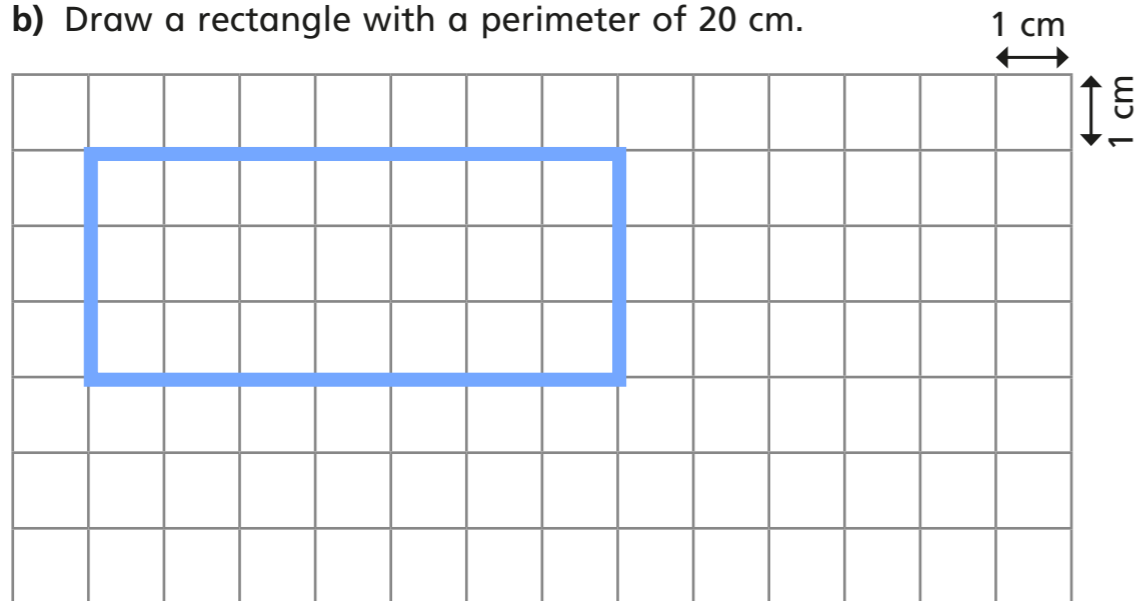

Talk about your method with a partner.



2 Draw the diagrams accurately.

a)

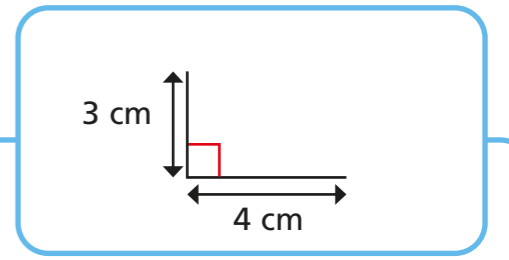

b)

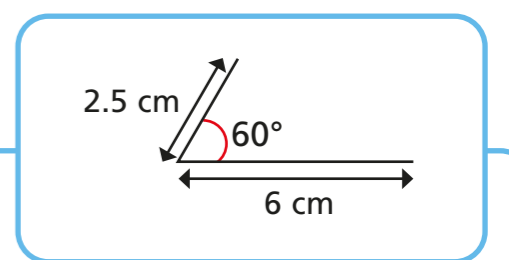

c)

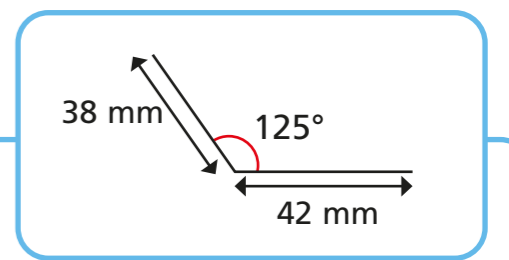

- 3 Aisha draws a triangle.

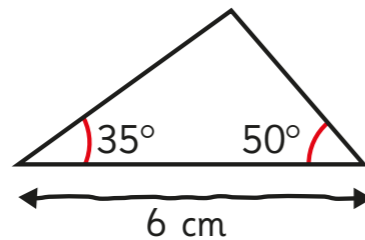

Make an accurate drawing of Aisha's triangle.



- 4

I have drawn a right-angled triangle. The two shorter sides are 4.5 cm and 6 cm.



a) Make an accurate drawing of Tommy's triangle.



b) Use your drawing to find the length of the longest side.

7.5 cm

- 5 Draw the triangle accurately.

a)

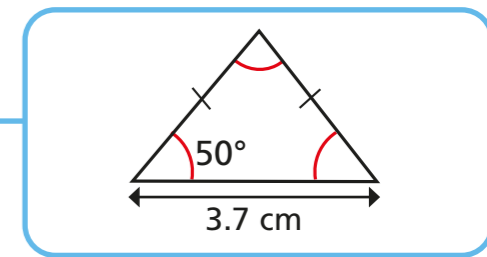

b) Measure the vertical height of the triangle.

2.2 cm

c) Work out the area of the triangle.

4.07 cm²

- 6 Here is a technical drawing of a toy train.

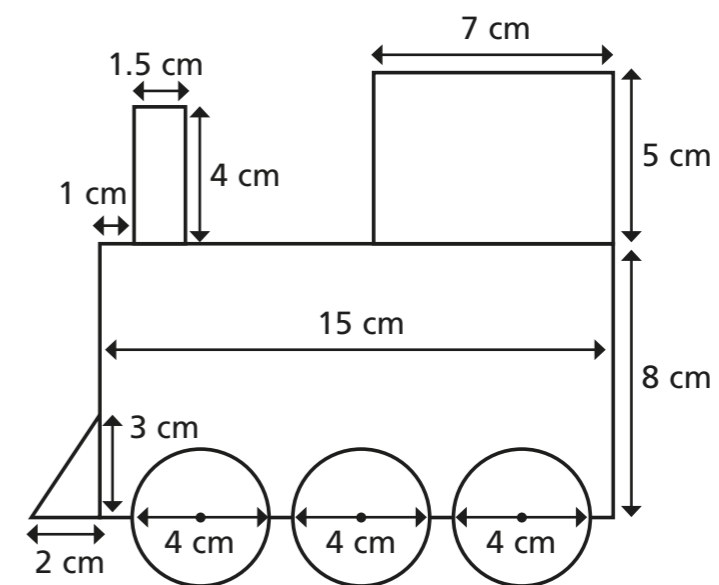

Make an accurate drawing of the toy train on a sheet of squared paper.

